

**Cameras**

**KIEV-88**

**KIEV-88TTL**



УФСР • МОСКВА

**REPAIR  
MANUAL**



УФСР • МОСКВА

## 1. GENERAL

The KIEV 88 is a single-lens reflex half-plate camera with a metallic curtain shutter and interchangeable magazines.

The KIEV 88 TTL camera as distinct from the KIEV 88 camera is completed with a prismatic viewfinder with a built-in exposure meter which determines the exposure by the light which has passed through the lens.

For carrying out repair operation it is required to determine the assembly unit in which a trouble has arisen, and using Section 3 find the fault in an appropriate assembly unit.

It is recommended to use the equipment and tools listed in Section 2 of the present Manual. In carrying out the repair operations take care not to damage the shutter curtains because they are made of very thin stainless steel.

## 2. EQUIPMENT, TOOLS AND AUXILIARY MATERIALS

1. Exposure time and synchronizer checking device ПТ-611
2. Exposing device 3ФК-М-5 с6/с602
3. Exposure metering device КЮ-1100М
4. Resolution checking device КЮ-1012
5. Camera adjusting device КЮ-761М
6. Device 3ФК-П-2 с6/с603 for checking working length ( $3.5 \pm \pm 0.02$ ) mm of the magazine
7. Microscope МБС-9
8. Megohmmeter М4101/3
9. Magnifying glass 4<sup>x</sup>
10. Wrench 7812-4575 for shutter cocking (cocking knob screw)
11. Wrench 7812-4581 for socket setting
12. Wrench 7812-4574 for synchronizer
13. Oil metering device 7874-4057
14. Gasoline can 7803-4020
15. Developing tank 6×6 cm
16. Gauge 8371-4240 for determining mirror position at an angle of 45°
17. Gauge 8701-4484 for checking camera working length ( $82.1 \pm \pm 0.05$ ) mm

## 3. TROUBLESHOOTING

18. Reference standard 8431-4400 for dimension  $(82.1 \pm 0.05)$  mm
19. Indicator (GOST 577-68\*)
20. Depth gauge 8511-4001
21. Soldering iron 0838-4001A
22. Solder and flux kit 0855-5006
23. Gauge 8459-4335 for setting lens fixing arm
24. Cutting pliers 7814-0132 MH513-60
25. Wrench 7822-4788 for viewfinder plug
26. Kit 7803-4018 for optics cleaning
27. Tooth brush
28. Screwdrivers: 7810-0001; 7810-0002; 7810-0003; 7810-0004; 7810-0005; 7810-0006
29. Pincers 7814-0002, MA560-60
30. Pliers 7814-0081, MH508-60
31. Cleaning stick 7885-4012
32. Fibre hammer 7850-0081 MH536-60
33. Saddler's knife 3809-4001
34. Special axle 8.310.058
35. Gauge block 7030-8128 for checking flatness
36. Indicating device 8701-4534 for checking camera working length  $(78.6 \pm 0.02)$  mm
37. Reference standard 8431-4683 for adjusting dimension  $(78.6 \pm 0.02)$  mm
38. Appliance 7872-9317 for checking synchronizer
39. Frosted glass 3ФК-КЮ-226с61/с603
40. Solder Пp2 ПОССУ-61-0,5 (GOST 21931-76)
41. Flux ФКТ ТВ81-05-51-76
42. Cement БФ-4 (GOST 12172-74)
43. Grease ОКБ-122-7 (GOST 18179-72)
44. Oil MH-30 (GOST 8781-71)
45. Enamel ПФ-115 red-orange (GOST 6465-76)
46. Cotton wool for optical industry (GOST 10477-63)
47. Petroleum ether
48. Ethyl alcohol, industrial rectified
49. Aviation gasoline Б-70 (GOST 1012-54)
50. Cambric cloth
51. Wrench 7811-0002
52. Gauge 8389-4104
53. Wrench 7812-4627

\* State standard.

Trouble	Cause	Remedy
<b>Camera</b>		
Mirror fails to be locked in lower position during shutter cocking	Eccentric bushing 1 (Fig. 12) turned or rest of dog 9 (Fig. 39) is worn out of true	Disassemble camera as instructed in Pars 4.1-4.4; 4.7. Adjust locking of cam 4 (Fig. 12) by lever 3 with up to 0.2 mm clearance between lever and cam projection with shutter fully cocked. Perform adjustment by turning eccentric bushing 1 with screw 2 loosed. In case dog 9 (Fig. 39) is worn out of true additionally disassemble camera as instructed in Par. 4.9. Unscrew screw 11 in cocking knob, remove dog 9 and replace it by new one. Install removed cocking knob in place as instructed in Par. 6.6 and check its locking. Assemble camera in sequence reverse to disassembling and adjust it as instructed in Pars 7.1-7.2.
Curtains fail to operate	First curtain 5 (Fig. 18) is damaged, tape (black) of first curtain is broken or second curtain 16 (Fig. 14) is damaged, tape (white) of second curtain is broken	Disassemble camera as instructed in Pars 4.1-4.12. Additionally disassemble shutter as instructed in Pars 5.1-5.7 to replace first curtain and Pars 5.8, 5.9 to replace second curtain. Assemble shutter as instructed in Pars 6.1-6.17 and adjust it as instructed in Pars 7.1, 7.2. Assemble and adjust camera as instructed in Section 8
Violated meshing of magazine gears with camera (movable tooth fails to enter recess)	Teeth of gear 29 (Fig. 14) worn out	Disassemble camera as instructed in Pars 4.1-4.5, 4.7-4.12, 5.1, 5.2. Unscrew screw 7 (Fig. 14) with left-hand thread and remove gear 6. Unscrew screw 4 loosen screw 7 (Fig. 16) and withdraw tie rod 32 (Fig. 14). Unscrew screw 25, remove gear 29 and replace it with new one. Assemble and adjust shutter as instructed in Pars 6.6; 6.15-6.17. Assemble and adjust camera as instructed in Section 8
In cocking the shutter the cocking knob fails to be locked against reverse turning	Spring 5 (Fig. 14) revolves or pawl 3 is tight to rotate on axle	Disassemble camera as instructed in Pars 4.1-4.12. Unscrew screw 7 (Fig. 14), remove gear 6, spring 5, wash and crimp the spring. Wash pawl 3, lubricate friction points with oil MH-30 and adjust smoothness of rotation. Assemble parts in sequence reverse to disassembling. Assemble shutter as instructed in Par. 6.6 and check interlocking. Assemble and adjust camera as instructed in Section 8
Exposure time is out of tolerance	Violated positions of impeller 9 (Fig. 25), eccentric pin 1 or eccentric pin of dog 13 (Fig. 17)	Disassemble camera as instructed in Pars 4.1-4.12. Fit cocking knob onto shutter as instructed in Par. 6.6. Adjust exposure time as instructed in Pars 7.1, 7.2. Assemble and adjust camera as instructed in Section 8
Lens diaphragm fails to be fully opened in cocking the camera	Upset dimension $(14.6-0.1)$ mm between lever 1 (Fig. 5) and bearing ring 2	Remove lens from camera as instructed in Par. 4.1. Measure with depth gauge 8511-4001 dimension $(14.6-0.1)$ mm from bearing ring 2 (Fig. 5) surface to surface of lever 1 with shutter cocked and adjust it by installing washers 3 (Fig. 20) under screw 2 with

Continued

Trouble	Cause	Remedy
Low resolution	Violated adjustment of viewfinder 2 (Fig. 3)	wrench 7812-4627. Install lens in place and check diaphragm operation Disassemble camera as instructed in Pars 4.3, 4.5. Adjust camera as instructed in Par. 8.12 and assemble it in sequence reverse to disassembling
Synchronizer fails to operate	Contacts a, b (Fig. 26) burnt	Disassemble camera as instructed in Pars 4.1, 4.2. Cock shutter at exposure time "B" and open curtains by release button. Unscrew screws 4 (Fig. 26) and remove synchronizers. Clean and wash with alcohol the contacts. Install synchronizers in place and check their operation as instructed in Par. 8.6. Assemble camera in sequence reverse to disassembling
Indicator fails to be locked in shutter cocking	Wear out of lug of indicator 19 (Fig. 14) or plate of indicator 19 deformed	Disassemble camera as instructed in Pars 4.1-4.12 and additionally in Par. 5.1. Straighten lug of indicator 19 (Fig. 14) or indicator plate so that during shutter cocking the indicator set in place will be locked in upper position and will operate during releasing. Assemble and adjust camera as instructed in Section 8
Lens fails to be locked when being fitted in camera	Lens lock 3 (Fig. 9) displaced in camera	Remove lens from camera as instructed in Par. 4.1. Using gauge 8459-4335 adjust lens lock 3 (Fig. 9) with screws 2 (Fig. 11) loosened. Finally fix screws 2 with cement БФ-4 and lock heads with enamel ПФ-115 (red-orange). Fit lens in place and check its locking
With lock button being shifted viewfinder hood fails to open	Walls and shields 3, 4, 5 (Fig. 42) of hood deformed	Remove hood from camera as instructed in Par. 4.3. Straighten walls and shields 3, 4, 5 (Fig. 42) till hood is opened freely and fit hood in place
With viewfinder hood folded cover fails to be locked	Spring 1 (Fig. 41) of lock 2 came off or lock is deformed	Remove hood from camera as instructed in Par. 4.3. Fit spring 1 (Fig. 41) in place or straighten lock 2 till smooth movement and locking are attained. Fit removed hood in place
Curtains come off in shutter cocking (middle of cocking)	Pawl 2 (Fig. 13) is inoperative	Remove cocking knob from camera as instructed in Par. 4.9. Determine fault. If pawl 2 (Fig. 13) is jamming, wear it till it moves freely, wash and lubricate with oil МН-30. If pawl fails to operate due to slackened or come off spring 3, fit spring in place into pawl slot or make it stronger by bending. Fit cocking knob in place as instructed in Par. 6.6 and check its operation by cocking and releasing the shutter
<b>Magazine</b>		
Magazine can be removed from camera with curtain shutter removed	Plate 3 (Fig. 35) fails to be interlocked with lever 2	Remove magazine from camera as instructed in Par. 4.2, and disassemble it as instructed in Par. 5.14. Straighten lug of plate 3 (Fig. 35) of latch so that with curtain shutter 4 (Fig. 6) removed the lug of lever 2 (Fig. 35) will interlock plate 3. Assemble

Continued

Trouble	Cause	Remedy
Transport mechanism fails to enter magazine housing	Hinged cramp 1 (Fig. 34) deformed	magazine in sequence reverse to disassembling. Check operation of lock or camera with curtain shutter 4 (Fig. 6) removed. Magazine without curtain shutter must not be able to be removed from camera. Adjust it as instructed in Par. 7.3 Remove transport mechanism 2 (Fig. 27) from magazine housing 1. Straighten hinged cramp 1 (Fig. 34) in point of bending. Handle 2 fixed on hinged cramp must freely enter toothed wheel 5 (Fig. 28) of magazine housing. Assemble magazine. In so doing transport mechanism should tightly adjoin the housing
Transport in magazine fails to ensure full number of frames	Worn out lever 3 (Fig. 33)	Disassemble magazine as instructed in Pars 5.10-5.13. Make arm of lever 3 (Fig. 33) in leverage 18 longer by 0.2-0.3 mm or replace lever 3 together with axle 23. Assemble magazine as instructed in Pars 6.18-6.25 and check it as instructed in Par. 6.26
Frames superimposed	Lever 3 (Fig. 33) came off	Disassemble magazine as instructed in Pars 5.10-5.13. Straighten lever 3 so that it slides over the middle of working part of cam of ratchet wheel 6 without coming off. Check operation of leverage. Assemble magazine as instructed in Pars 6.18-6.25 and check it as instructed in Par. 6.26
Displacement of figures of frame counter with respect to coumler window	Lever 7 (Fig. 33) or pawl 21 with lever 19 are inoperative	Disassemble magazine as instructed in Pars 5.10-5.13. Detect trouble. Tight rotation of lever 7 is remedied by washing with gasoline and lubrication of mating parts, jamming is eliminated by straightening upper plate 3 (Fig. 31). Wear is eliminated by drawing down and filing. Wear of pawl 21 (Fig. 33) is remedied by drawing down, deformed lever 19 has to be straightened or replaced. Assemble magazine as instructed in Pars 6.18-6.25 and check it as instructed in Par. 6.26
Counter fails to operate	Lever 19 (Fig. 33) is jammed	Disassemble magazine as instructed in Pars 5.10-5.13. Straighten, wash and lubricate lever 19 till it attains smooth and unobstructed motion. Assemble magazine as instructed in Pars 6.18-6.25 and check its operation as instructed in Pars 6.26
Film rewinding gear fails to return to initial position	Return spring 1 (Fig. 36) on gear 12 (Fig. 33) has jumped out. Jamming or play of gear over 0.1 mm	Disassemble magazine as instructed in Pars 5.10-5.13. Determine trouble. Fasten jumped out spring 1 (Fig. 36) on gear 12 (Fig. 33). Jamming or play of gear 12 over 0.1 mm is eliminated by straightening plate 3 (Fig. 31) till gear play of not over 0.1 mm is attained. Assemble magazine as instructed in Pars 6.18-6.25 and check it as instructed in Par 6.26
Film in magazine gets light-struck	Breakage of cord or screws 2 (Fig. 29) of frame 5 got loosened	Extract transport mechanism 2 (Fig. 27) out of magazine housing 1 as instructed in Par. 5.10. Glue with shellac cement a new cord into magazine housing Tighten screws 2

Continued

Trouble	Cause	Remedy
Magazine flag-film indicator fails to operate	Violated joint of magazine with camera	(Fig. 29) of frame 5 up to the rest. Set transport mechanism in place. Check the magazine as instructed in Pars 8.14, 8.15 Disassemble magazine as instructed in Par. 5.14. Straighten two lugs on plate 3 (Fig. 35) of latch 11 (Fig. 29) so that magazine can tightly join up the camera. Assemble magazine in sequence reverse to disassembling, check operation of flag-indicator 1 (Fig. 33) with camera and adjust as instructed in Par. 7.3.
Film fails to be re-wound	Broken or weakened springs on gears 8, 9 (Fig. 33)	Disassemble magazine as instructed in Pars 5.10—5.13. Remove gears 8, 9 and wash them in gasoline. Check operation of spring friction clutches. Upper gears must freely rotate counterclockwise and be locked by spring in clockwise direction. If required replace gears 8 and 9. Install gears in place with the mechanism set to first frame as instructed in Par. 6.20. Assemble magazine as instructed in Pars 6.23, 6.25 and check its operation as instructed in Par. 6.26

## Prismatic Viewfinder TTL

No indication when exposure meter is ON	No battery. Oxidized plates (contacts) 3 (Fig. 44) or wire 6 (Fig. 48) broken	Unscrew plug 1 (Fig. 44) by wrench 7812-4788 out of power supply casing. Install power source and check indication as instructed in Par. 7.5. If required trim contacts 3 and wash them with alcohol. In case of breakage of supply wire 6 (Fig. 48) disassemble viewfinder as instructed in Par. 5.16 and solder wire 6 according to diagram illustrated in Fig. 49. Assemble viewfinder in sequence reverse to disassembling and check indication in compliance with Par. 7.5
Light signals in field of vision fail to be switched with the change of illumination	Breakage of wire 1 (Fig. 47), 2, 3 or 4 of photoresistor 5	Disassemble viewfinder as instructed in Pars 5.15—5.17. Find point of breakage of wire 1, 2, 3 or 4 and solder it according to diagram illustrated in Fig. 49. Assemble viewfinder as instructed in Pars 6.28—6.31. Check and adjust it as instructed in Pars 7.5, 7.6
Some light signal fails to be switched on during exposure meter operation	No contact on potentiometer (calculator) (Fig. 50) or light-emitting diode D2, D3 or D4 (Fig. 49) out of order	Disassemble viewfinder as instructed in Par. 5.15. Wipe with alcohol races of washer 5 (Fig. 43) and contacts 16 (Fig. 50). Straighten contact springs till reliable contact is obtained. Additionally disassemble viewfinder as instructed in Pars 5.17, 5.18. Replace faulty light-emitting diodes D2, D3 or D4 (Fig. 49). Assemble viewfinder as instructed in Pars 6.27—6.31. Check and adjust it as instructed in Pars 7.5, 7.6
One or several light signals are constantly brightened	Breakage of resistor 3 (Fig. 48) in circuit of light-emitting diodes	Disassemble viewfinder as instructed in Pars 5.17, 5.18. Eliminate breakage of resistor 3. Assemble viewfinder as instructed in Pars 6.27, 6.28, 6.30, 6.31 and check it as instructed in Pars 7.5, 7.6

Continued

Trouble	Cause	Remedy
Wrong readings of exposure meter	Faulty calculator (Fig. 50)	Disassemble viewfinder as instructed in Par. 5.15. Set contacts of plate 1 (Fig. 50) on races of washer 5 (Fig. 43) of potentiometer (calculator) to initial position at the expense of moving them on screws 2 (Fig. 50). Contacts should be arranged evenly and slide over disks 17 to both sides from rest to rest of scale 3 evenly without seizing. Set fastener screws 2 on cement БФ-4. Assemble calculator as instructed in Pars 6.30, 6.31. Check and adjust viewfinder as instructed in Pars 7.5, 7.6. If required, replace potentiometer washer 5 (Fig. 43)

## 4. DISASSEMBLING THE CAMERA INTO BASIC ASSEMBLY UNITS

- 4.1. **Lens.** Depress button 1 (Fig. 6), turn lens 2 counterclockwise through 1/3 revolution and detach it.
- 4.2. **Magazine.** Shift button 3 (Fig. 6) of magazine 5 in the direction of the pointer-indicator and remove the magazine with curtain shutter 4 closed.
- 4.3. **Hood or viewfinder TTL.** Shift hood 1 (Fig. 1) or viewfinder TTL 2 (Fig. 2) on the guides of housing of camera 2 (Fig. 1) towards the magazine and remove the hood or viewfinder TTL.
- 4.4. **Shields.** Unscrew screw 6 (Fig. 20) which fastens bottom 5 to the post inside the camera through the opening of lens bearing ring 2 (Fig. 5). When pressing the bottom extract two retaining tabs of right-hand wall 2 (Fig. 9) from the bottom slots and remove first the wall and then shield 4 (Fig. 20) and bottom 5.
- 4.5. **Viewfinder.** Unscrew four screws 1 (Fig. 3) out of the camera housing, remove four straps 3 and extract viewfinder 2.
- 4.6. **Mirror.** Place frame 2 (Fig. 4) with mirror 6 into horizontal position. By depressing hold-down 4 unlock washer 3 of axle 1 in the hold-down slot. Remove the axle and the frame with the mirror.
- 4.7. **Lens bearing ring.** Unscrew four screws 3 (Fig. 5) out of the housing, remove bearing ring 2, packing ring 5 and shims 4, 6 having marked their position on the housing.
- 4.8. **Socket.** Screw socket 6 (Fig. 6) out of the housing using wrench 7812-4581, take off socket 6 and ring 7.
- 4.9. **Cocking knob.** Cock and release the shutter at exposure "B". In this position unstick facing 1 (Fig. 2) from the surface of knob 2 (Fig. 7). Mark with mark a the position of disk 3 with the knob. Unscrew screw 1 with wrench 7812-4575 and carefully remove the knob. Mark with mark b (Fig. 8) the position of flange of axle 3 on the flange of cam 2 and mark with mark c (Fig. 39) the position of the tooth of the cylinder wheel 1 on base 5 of the cocking mechanism.

Set the mirror to the lower position corresponding to 45°. Lock cam 4 (Fig. 12) with lever 3 by rotating the cam clockwise. Unscrew three screws 6 (Fig. 8), one screw 1 (Fig. 13) and remove the base of the cocking knob mechanism from plate 1 (Fig. 37).

4.10. **Tripod nut and post.** Screw axle-screw 1 (Fig. 20) with wrench 7811-0002 out of post 3 (Fig. 10) and remove lever 1 (Fig. 5). Unscrew six screws 1 (Fig. 10) which fasten nut 2, post 3 and remove them from the camera.

4.11. **Shoe (for cableless flashlamp).** Unscrew four screws 1 (Fig. 23) out of the camera housing and remove shoe 5, contact 3, two springs 2 and two washers 4.

4.12. **Shutter.** Remove facing 7 (Fig. 5) from the housing on the lens bearing end. Unscrew four screws 1 (Fig. 9) to be found under the facing. Extract shutter casing 2 (Fig. 14) out of the housing (casing) by depressing the shutter casing from the lens bearing end. Take pusher 9 (Fig. 5) out of release button 8 and lever 1 (Fig. 18) of synchronizer out of the shutter casing.

## 5. DISASSEMBLING THE ASSEMBLY UNITS

### SHUTTER

5.1. **Disassembling the indicator.** Unscrew two screws 21 (Fig. 14) and remove indicator 19.

5.2. **Disassembling the viewfinder.** Unscrew four screws 5 (Fig. 16) which fasten strap 4, remove the latter and rest 6. Unscrew three screws 2 and remove guide 1.

5.3. **Removing the frame with axles.** Unscrew four screws 3 (Fig. 15), one screw 2, two screws 31 (Fig. 14) and three screws 8 (Fig. 21). Shift bushing 2a (Fig. 15) and bushing 7b with a ball (Fig. 21) so that the axle ends leave the holes and remove two axles 3 (Fig. 16), 8 and frame 1 (Fig. 14). Install special axle 8.310.058 instead of the removed axles.

5.4. **Removing the strap.** Unscrew two screws 13 (Fig. 14) and remove straps 11, 12.

5.5. **Removing the first curtain.** Disassemble the shutter as instructed in Pars 5.1–5.3. Shift bearing 2 (Fig. 18) of the axle of the roller of curtain 5 and remove the curtain out of the housing.

5.6. Put special plate sizing 90×30×1.5 mm under the curtain. Unbend two strips 1 (Fig. 40) which secure the tape. Unglue the ends and remove the tape out of the curtain slots.

5.7. **Removing the tape of the first curtain.** Unwind the black tape (having noted the number of turns) from axle 15 (Fig. 14). Turn split ring 3 (Fig. 19) and ring 9 (Fig. 16). Remove the tape with pin 2 (Fig. 19) from one end and the second tape with pin 10 (Fig. 16) from the other end of the axle.

5.8. **Removing the second curtain.** Disassemble the shutter as instructed in Pars 5.1–5.4. Remove axle 3 (Fig. 18) together with the pipe having released it from the holes of bushings 2b (Fig. 15) and 7a (Fig. 21). Push bearing 2 (Fig. 18) out of the housing and remove roller 4.

Unscrew screw 2 (Fig. 15) which fastens frame 1. Push bearing 1a out of the inner part of the housing and remove the roller of curtain 16 (Fig. 14) having brought it out of meshing with lower gear 8 (Fig. 17) of the exposure time mechanism.

5.9. **Disassembling the second curtain.** Remove roller 4 (Fig. 18) with the white tape from curtain 16 (Fig. 14) as instructed in Par. 5.6.

### MAGAZINE

5.10. **Removing the transport mechanism and the curtain shutter.** Open the handle of lock 3 (Fig. 27), turn it fully counterclockwise, extract transport mechanism 2 out of the housing and curtain shutter 4 (Fig. 6).

5.11. **Removing the cover from the magazine housing.** Remove plate 2a (Fig. 28) from the bottom of housing 2, unscrew screws 1, 4, screws 2 (Fig. 29) and 10 which fasten cover 3 to the housing, and remove the cover.

5.12. **Removing the rewinding handle.** Remove leather facing 6 (Fig. 29) from handle 7, unscrew screw 3 (Fig. 30) out of the handle, remove the handle and washer 1.

5.13. **Removing the upper plate from the magazine mechanism.** Unscrew three screws 5 (Fig. 31) and remove plate 3 from five axles 1 (the axles must remain in their places in the housing). Take off washers 12 (Fig. 32) and 13, scale 1 of the counter, gear 15 (Fig. 33) with axle 1 (Fig. 31). Release the end of spring 9 (Fig. 32) secured in the hole of gear 12 (Fig. 33) and remove the gear. Remove axle-screw 16, bring aside released lever 19 and remove leverage 18 from the axles.

5.14. **Removing the frame.** Unscrew eight screws 10 (Fig. 29) and one screw 2 which fasten frame 5 and remove the latter. Take off latch 11.

### PRISMATIC VIEWFINDER TTL

5.15. **Removing the calculator.** Remove facing 10 (Fig. 50) with spacer 11. Unscrew screw 9 from axle 19 of the casing. Take off hand-wheel 12, washer 8, scales 6 and 7, ring 13, gasket 4, and scale 3 in assembly with plates (contacts) 1.

5.16. **Removing the switch.** Remove facing 2 (Fig. 44), screw four screws 1 (Fig. 46) out of casing 2 and take off switch 3.

5.17. **Removing the exposure meter.** Remove facings 6 (Fig. 43) and 2 (Fig. 44). Unscrew four upper screws 1 (Fig. 45), 5 (Fig. 46) and two lower screws 4, take housing 6 (Fig. 47) with the eye-piece from casing 7 (Fig. 48). Screw out six lower screws 1 (Fig. 45), four screws 5 (Fig. 46) which fasten the exposure meter base to the casing, and take exposure meter 8 (Fig. 48) out of casing 7.

5.18. **Removing the plate from the unit of light-emitting diodes.** Unscrew two screws 1 (Fig. 48) from the bracket of light-emitting diode unit 4 and remove plate 5.

## MAGAZINE

7.3. Checking the magazines. Frame 3 (Fig. 24) of the magazine must be flush with cover 4 or be sunk not over 0.1 mm; cover 4 and two rests 1 should be in one plane. Carry out adjustment by straightening the magazine parts on a plate.

Check and adjust size  $3.5 \pm 0.02$  mm of the magazine between the mounting surface and the surface of clamping strap 6 pressed to rollers 2. The checking and adjustment are performed on device 3ФК-П-2с6/с603 by changing position of rollers 2, straightening picture frame 5. In this case the nonparallelism of the mounting surface should be not over 0.02 mm.

## PRISMATIC VIEWFINDER TTL

7.4. Checking the exposure meter readings. Insert the power source, section 4ПЛ-53, into the viewfinder socket so that sign "—" is at the plug end and close it with the plug. Check the power source for fitness. Monitoring is performed automatically with the exposure meter switch set with its index against the green dot. Blinking of the middle green signal indicates drop of power source voltage below the permissible value (4.5 V).

7.5. Install the viewfinder onto device КЮ-1100М. Check operation of the viewfinder exposure meter at a voltage of  $5 \pm 0.5$  V over the whole range of brightnesses from 1.6 to 13 000 cd/m<sup>2</sup> in compliance with Table 2.

Table 2

Brightness, cd/m <sup>2</sup>	Film speed, GOST unit	Aperture	Exposure time, s	Brightness, cd/m <sup>2</sup>	Film speed, GOST unit	Aperture	Exposure time, s
1.6	130	2.8	1/2	200	130	2.8	1/250
3.2		2.8	1/4	400		2.8	1/500
6.4		2.8	1/8	800		2.8	1/1000
12.5		2.8	1/15	1600		4	1/1000
25		2.8	1/30	3200		5.6	1/1000
50		2.8	1/60	6400		8	1/1000
100		2.8	1/125	13000		11	1/1000

The exposure time parameters are determined when the middle green signal is glowing. If illumination is insufficient or excessive luminiscent red signals ⊙ — "insufficient light"; ✱ — "excessive light" should be seen in the eyepiece field of vision above the viewfinder image field.

The checking is to be performed at the open aperture and film speed of 130 GOST units set on the calculator scale. Stop value 2.8 must be set against the calculator index. When exposure time 1/30 s is set against stop value 8 (on calculator) it is required to select such brightness on device КЮ-1100М that middle green signal will glow. In this case the brightness value should be within the range of 140—282 cd/m<sup>2</sup>. When stop value 5.6 is set on the calculator against exposure time 1/30 s signal

✱ should glow, and when stop value 11 is selected signal ⊙ should glow. Glowing of two adjacent signals at the very beginning of aperture changing is allowable. If required the adjustment can be performed by shifting the contacts along the graphite washer track with disassembling and reassembling the calculator knob as instructed in Pars 5.15, 6.30, 6.31.

Electric contact must not be disturbed when rotating the calculator exposure time ring from rest to rest. Checking is to be performed with the viewfinder entrance window closed. Set the exposure meter switch against the green dot, in this case signal ⊙ should glow. Signal ⊙ should glow without blinking when the calculator exposure time ring is slowly rotated from rest to rest. No glowing of signal ✱ is allowable.

7.6. Te exposure meter operation is to be checked with the use of Table 2.

## 8. ASSEMBLING THE CAMERA

## INSTALLING THE SHUTTER

8.1. Check the planeness of the end face of the datum surface of the housing of magazine 3 (Fig. 1) on plate 7030-8128, no rocking is allowed. Straighten, if required. Take the cocking knob off the shutter as instructed in Par. 4.9. Install lever 1 (Fig. 18) on the shutter housing. Set the shutter housing into the camera housing as far as it will go. In this case frame 1 (Fig. 14) must be flush with the shutter housing end face, the allowable sinking is not over 0.1 mm. Perform adjustment with washers 1a (Fig. 9) by putting them between the shutter and camera housings. Secure the shutter in the housing with four screws. Install the cocking knob onto the shutter as instructed in Par. 6.6. Cock the shutter. Set exposure time "B" and check shutter operation during release.

8.2. Put nut 2 (Fig. 10), prop 3 onto the housing and secure it with six screws 1 up to the stop.

8.3. Put lever 1 (Fig. 5) onto prop 3 (Fig. 10) and secure with axle-screw 1 (Fig. 20) having preliminarily screwed it into the prop with wrench 7811-0002. Adjust the lever on a radius with the aid of gauge 8389-4104 by shifting it on screw 1. Fully tighten screw 1.

8.4. Install contact 3 (Fig. 23) on the camera housing having preliminarily put removed washers 4, then two springs 2, shoe 5 and fasten with four screws 1 up to the stop.

8.5. Set ring 7 (Fig. 6) onto the camera housing with the dog inserted into the fork of lever 1 (Fig. 18) and fasten it with socket 6 (Fig. 6). In this case the rotation of the ring must be smooth from rest "P" to rest "X" with the minimum play.

8.6. Install the camera onto device ПТ-611. Check and adjust, if required, exposure times as instructed in Par. 7.2. Check operation of the synchronizers with device 7872-4317. Cock the shutter, set exposure time 1/30 s and set the synchronizers to position "X". The contacts must close after full opening of the frame but not later than after 2 ms, and they must close at setting "FP"  $16 \pm 4$  ms before exposure begins. The duration of contacting till first unsticking of contacts must be at least 2.5 ms and

the quality of contacting should be sufficient for firing electronic flash-lamps or flash bulbs.

8.7. Apply a thin coat of cement onto facing 1 (Fig. 2), hold it till cement stops sticking and cement onto the cocking knob.

Apply a thin coat of cement onto facing 7 (Fig. 5), hold it till cement stops sticking and cement it onto the surface of the housing at the side where the lens is fitted.

#### INSTALLING THE BAYONET RING. CHECKING AND ADJUSTING THE CAMERA WORKING LENGTH

8.8. Put ring 2 (Fig. 5) onto the camera having preliminarily put adjusting shims 4, 6 and packing ring 5 according to marks and secure it with four screws 3. Install the camera onto device 8701-4534. Check the camera working length ( $78.6 \pm 0.02$ ) mm from the bearing surface of ring 2 to the datum surface of the housing of camera 2 (Fig. 1), in this case the error in parallelism of planes of these surfaces must not exceed 0.02 mm. Adjust the device indicator with the use of reference standard 8431-4683, the working length has to be adjusted by abovementioned shims.

#### CHECKING AND ADJUSTING THE WORKING LENGTH OF THE CAMERA WITH MAGAZINES

8.9. Check the camera working length ( $82.1 \pm 0.05$ ) mm with a set of magazines by measuring from the plane of ring 2 (Fig. 5) to the upper plane of clamping strap 6 (Fig. 24). Take measurements with indicating gauge 8701-4484 having set the dimension of 82.2 mm by reference standard 8431-4400.

Perform checking at exposure time "B" with the aperture fully open and curtain shutter 4 (Fig. 6) taken out of the magazine.

#### CLEANING AND MOUNTING THE OPTICAL UNITS

8.10. Clean the working surface of the mirror with a cotton wool pad moistened with petroleum ether. No smears and fatty films are permissible.

8.11. Clean the optical elements of viewfinder 2 (Fig. 3) from two external sides. Install the viewfinder into the camera frame with the Fresnel lens down onto the adjusting screws and secure it with four straps 3 with screws 1.

#### ADJUSTING THE CAMERA

8.12. Fit the lens into the camera. Install the camera onto device KIO-761M and secure it there. Fully open the lens aperture, set the distance scale to "infinity" ( $\infty$ ). Cock the shutter at exposure time "B". The image of the device focusing chart on the frosted glass should be sharp and be located in the center of the field of vision. Install device

3ΦK-KIO-226c6

c603

with a frosted glass into the camera aperture, open the

aperture by releasing the curtain. The image also must be sharp. Carry out adjustment by shifting the screws located under viewfinder 2 (Fig. 3).

#### INSTALLING THE SHIELD, BOTTOM, AND WALLS

8.13. Remove lens 2 (Fig. 6) from the camera as instructed in Par. 4.1. Put bottom 5 (Fig. 20) into the camera through the opening under the lens so that the locking rest enters the bottom slot and secure the bottom on prop 3 (Fig. 10) with screw 6 (Fig. 20). Following this install right-hand wall 2 (Fig. 9) and fix it with tabs in the bottom slots, install a shield in a similar manner. Install hood 1 (Fig. 1) and lens 2 (Fig. 6) on the camera.

#### CHECKING THE LIGHT-TIGHTNESS

8.14. Load the set of magazines with a film of sensitivity of 65 GOST units. Fit the magazine on the camera. Take off curtain shutter 4 (Fig. 6), fully open the lens aperture. Install the camera into device 3ΦK-M-5c6/c602. Switch on light for 5 min. Perform checking with the shutter cocked and released with all the magazines which make part of the camera set with the curtain shutters fitted in place. The developed film must have no over-all fog or local light fog.

#### CHECKING THE RESOLUTION

8.15. The resolution is checked by shooting on three pictures the focusing charts ΓOI of the KIO-1012 device with the lens relative aperture fully open, exposure time 1/125 s, "infinity" distance, "Photo-65" film.

Develop the film in standard developer during 12 minutes at a temperature of  $(20 \pm 1)$  °C (fast developer may be used). The resolution value is determined by the last square in which and up to which it is possible to count the lines in four directions. The film must be free from over-all fog or local light fog, the resolving power must correspond to the camera certificate data. The focusing charts are interpreted with the aid of microscope MБC-9 with magnification of at least  $10\times$ . When interpreting the exposed pictures pay attention to the distance between pictures and to the evenness of picture density (there should be no noticeable streaks). The film must accommodate twelve full pictures. Overlapping of pictures is impermissible.



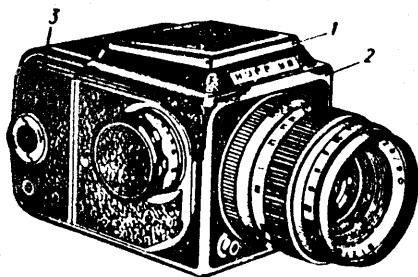

Fig. 1. Camera KIEV-88:  
1 — hood 5.811.000; 2 — camera 3.822.052; 3 — magazine 3.930.012

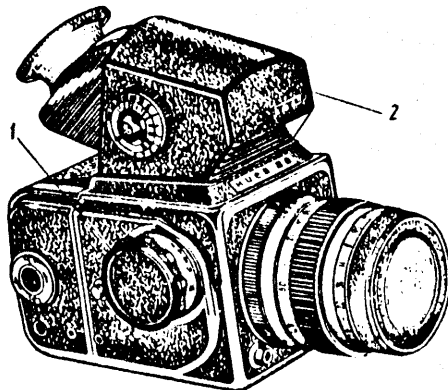

Fig. 2. Camera KIEV 88 TTL (first view):

1 — facing 8.645.043; 2 — prismatic viewfinder TTL 3.811.115

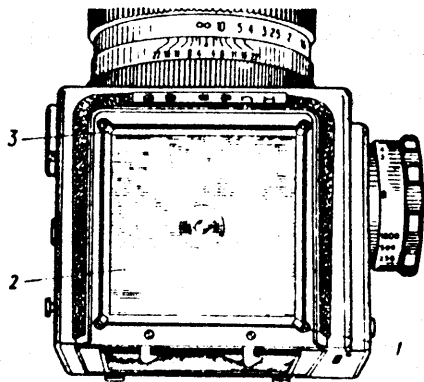

Fig. 3. Camera KIEV 88 (first view):  
1 — screw 8.900.034; 2 — viewfinder 5.811.079;  
3 — strap 8.605.923

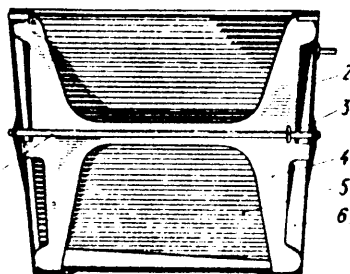

Fig. 4. Mount with mirror:

1 — axle 8.300.012; 2 — mirror frame 6.431.003;  
3 — clamping washer 8.946.005; 4 — hold-down 8.387.029; 5 — plate 8.610.015; 6 — mirror 7.230.001

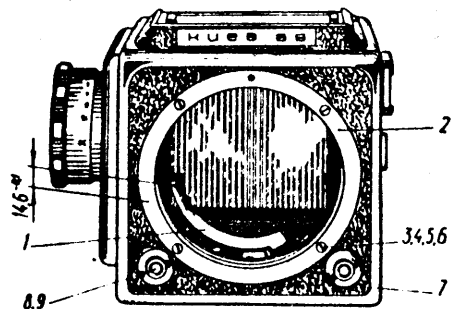

Fig. 5. Camera KIEV 88 (second view):  
1 — lever 6.354.344; 2 — ring 8.241.011; 3 — screw 8.903.041; 4 — shim 8.680.000; 5 — packing ring 8.680.007; 6 — shim 8.680.010;  
7 — facing 8.645.045; 8 — button 6.356.003;  
9 — pusher 8.352.001

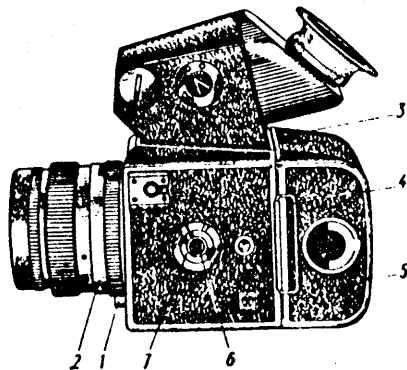

Fig. 6. Camera KIEV 88 TTL (second view):

1 — button 6.356.002; 2 — lens VEGA-12B 3.873.028 (VOLNA-3B 3.873.061); 3 — button 8.337.507; 4 — curtain shutter 6.272.006; 5 — magazine 3.930.012; 6 — socket 6.601.002; 7 — ring with button 6.251.001

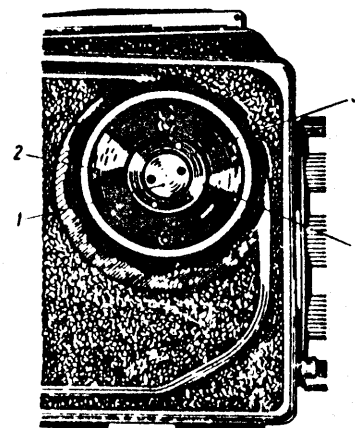

Fig. 7. Cocking knob on housing:

1 — screw 8.919.006; 2 — knob 6.395.004;  
3 — disk 6.325.000; a — mark

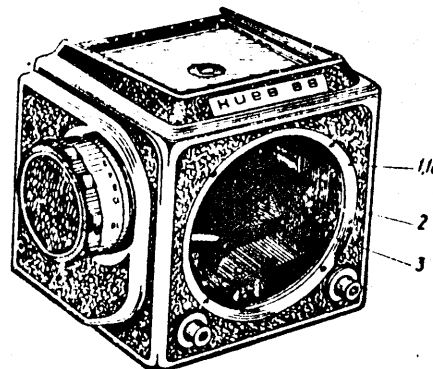

Fig. 9. Camera KIEV 88 (third view):

1 — screw 8.903.013; 1/a — washer 8.680.876;  
2 — right-hand wall 8.613.003; 3 — lens lock 6.275.003

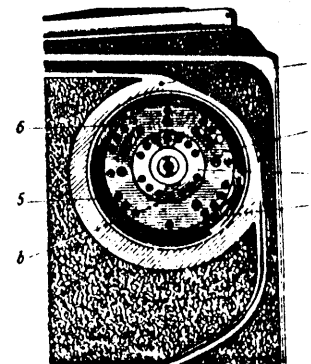

Fig. 8. Base of cocking knob on housing:

1 — scale index 8.903.012; 2 — cam 6.365.002; 3 — axle 8.314.366; 4 — screw 8.903.012; 5 — base 6.120.116;  
6 — screw 8.905.006; b — mark

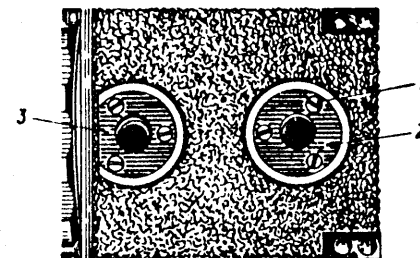

Fig. 10. Tripod nuts on housing:

1 — screw 8.903.042; 2 — nut 8.939.018; 3 — prop 8.120.466

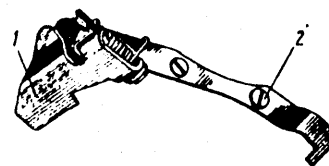

Fig. 11. Lens lock:

1 — lock 6.275.003; 2 — screw 8.909.429

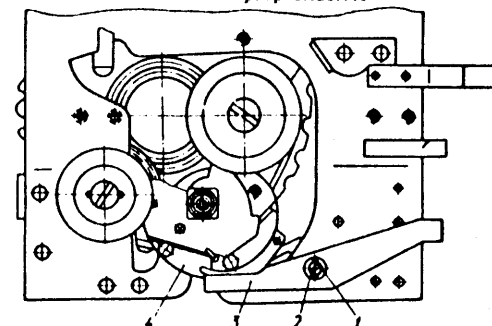

Fig. 12. Plate with cocking knob:

1 — bushing 8.229.026; 2 — screw 8.900.021; 3 — lever 8.332.045; 4 — cam 6.365.027

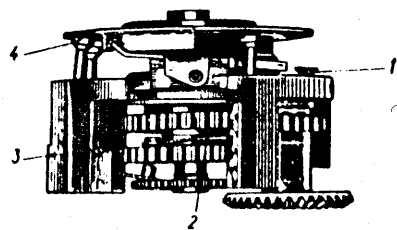

Fig. 13. Base of cocking knob:

- 1 - screw 8.903.337; 2 - pawl 8.361.121;
- 3 - spring 8.385.219; 4 - screw 8.905.006

Fig. 14. Shutter with cocking knob removed:

- 1 - frame 8.000.001; 2 - casing 8.020.008;
- 3 - pawl 8.361.105; 4 - screw 8.318.011;
- 5 - spring 8.311.012; 6 - gear 8.413.011;
- 7 - screw 8.900.032; 8 - plate 6.120.119;
- 9 - gear 8.410.010; 10 - lower half coupling 8.310.002; 11 - strap 8.600.021; 12 - strap 6.420.002; 13 - screw 8.903.029; 14 - screw 8.903.010; 15 - axle with tape 6.301.005; 16 - second curtain 6.437.801; 17 - screw 8.900.029; 18 - spring 8.385.035; 19 - indicator 6.057.001; 19a - guide 8.203.008; 20 - strap 8.600.018; 21 - axle-screw 8.318.025; 22 - axle 8.310.018; 23 - rest with rivet 6.278.003; 24 - screw 8.900.021; 25 - screw 8.900.012; 26 - pin 8.960.226; 27 - cam 8.360.508; 28 - gear 8.413.001; 29 - gear 6.450.011; 30 - rest 8.366.034; 31 - screw 8.900.011; 32 - tie rod 8.352.002; 33 - axle 8.310.016; 34 - plate 8.610.018

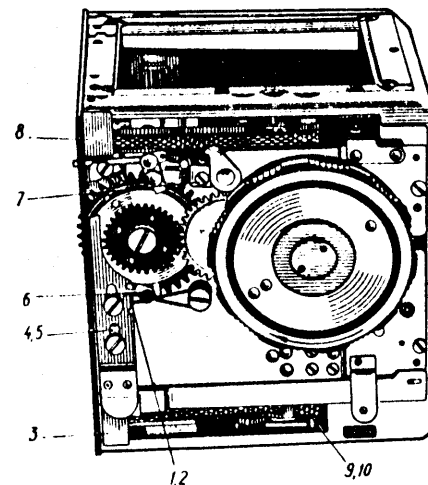
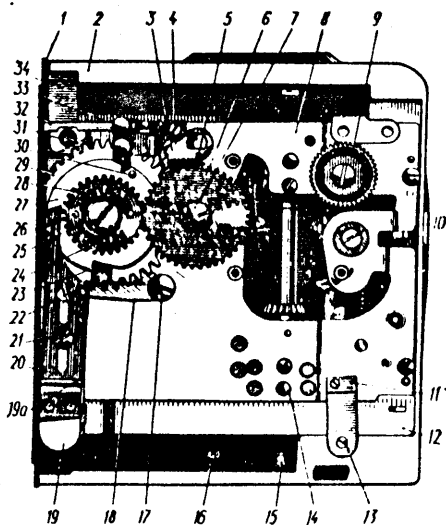

Fig. 16. Shutter (second view):

- 1 - guide 8.203.008; 2 - screw 8.903.013;
- 3 - axle 8.310.013; 4 - strap 8.600.018; 5 - screw 8.903.013; 6 - rest with rivet 6.278.003; 7 - screw 8.902.003; 8 - axle 8.310.012; 9 - split ring 8.245.002; 10 - pin 8.960.015

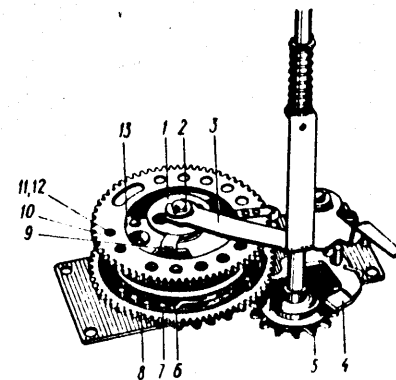

Fig. 17. Exposure time mechanism:

- 1 - shaft-dog 8.314.024; 2 - washer 8.916.001;
- 3 - lever 6.354.021; 4 - lever 6.354.021; 5 - gear 8.440.001; 6 - catch 6.272.007; 7 - rest 8.366.039; 8 - gear 8.410.030; 9 - holder 8.126.019; 10 - gear with tooth 6.378.000; 11 - strap 8.683.020; 12 - rivet 8.959.003; 13 - dog 6.360.002

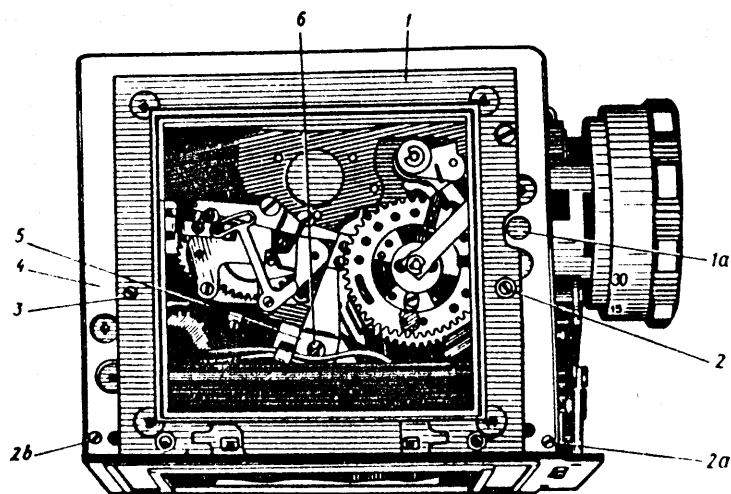

Fig. 15. Shutter (first view):

- 1 - frame 6.122.302; 1a - bearing 6.261.000; 2 - screw 8.903.013; 2a, 2b - bushing with ball 6.232.000; 3 - screw 8.903.036; 4 - casing 5.822.125; 5 - rest 6.278.002; 6 - screw 8.909.009

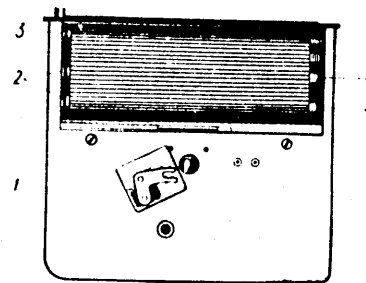

Fig. 18. Housing with curtains installed:

- 1 - lever 6.354.033; 2 - bearing 6.261.000;
- 3 - axle with pipe 6.309.001; 4 - roller 6.301.007; 5 - first curtain 6.437.806

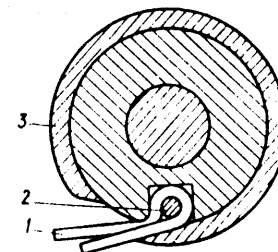

Fig. 19. Axle with fixed tape:

- 1 - first curtain 6.437.806; 2 - pin 8.960.010; 3 - split ring 8.245.001

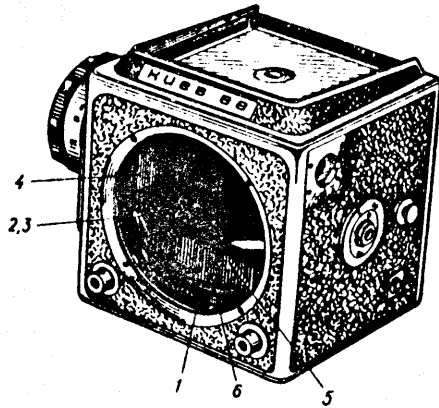

Fig. 20. Camera (fourth view):  
 1 - axle-screw 8.318.600; 2 - screw 8.900.689;  
 3 - washer 8.912.044; 4 - shield 4.642.076;  
 5 - bottom 8.613.345; 6 - screw 8.902.010

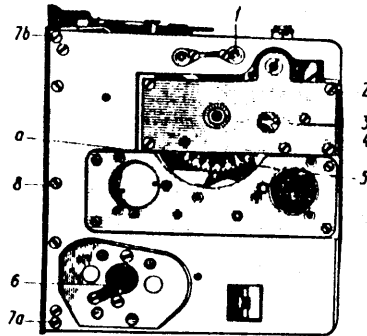

Fig. 21. Housing with mechanisms:  
 1 - sliding bearing 6.261.001; 2 - screw 8.903.013; 3 - lever 6.354.020; 4 - exposure time mechanism 5.822.001; 5 - gear 8.129.001; 6 - gear with rest 6.370.016; 7a, 7b - bushing with ball 6.232.001; 8 - screw 8.903.010; a - hole

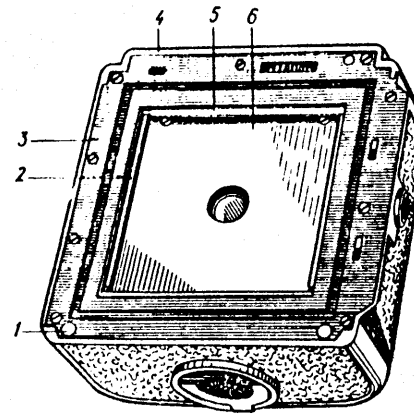

Fig. 24. Magazine as viewed from datum plane:

1 - rest 8.366.755; 2 - roller 8.393.000; 3 - frame 6.122.750; 4 - cover 6.170.001; 5 - picture frame 6.434.005; 6 - clamping strap 8.600.009

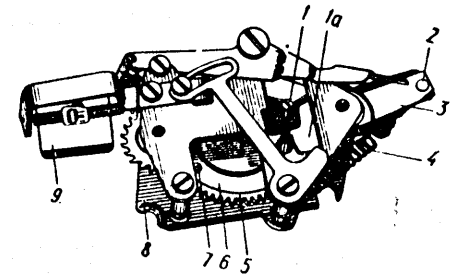

Fig. 25. Braking mechanism:

1 - eccentric pin 8.360.009; 1a - sector 6.376.500; 2 - rest 8.366.042; 3 - lever 6.354.028; 4 - spring 8.380.014; 5 - axle with gear 6.304.002; 6 - cover 8.050.024; 7 - screw 8.903.020; 8 - plate 8.070.616; 9 - impeller 6.395.006

Fig. 22. Gear with exposure time mechanism disk:

1 - cam 8.360.509; 2 - holder 8.126.018; 3 - cramp 8.667.017; 4 - spring 8.387.024; 5 - catch 8.262.001; 6 - gear with disk 6.379.000; 7 - bushing 8.227.038; 8 - plate 6.120.422

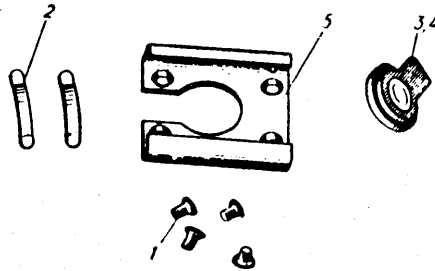
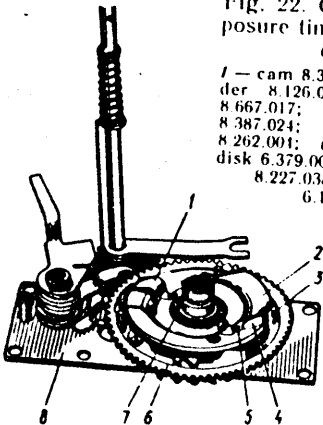

Fig. 23. Shoe (of cableless flashlamp):

1 - screw 8.905.762; 2 - spring 8.387.112; 3 - contact 6.622.305; 4 - washer 8.912.076; 5 - shoe 8.212.212

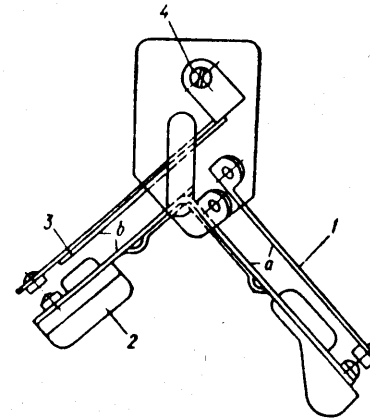

Fig. 26. Synchronizer:

1 - contact 6.622.011; 2 - contacts with rest 6.622.008; 3 - contacts 6.622.007; 4 - screw 8.906.017; a, b - contacts

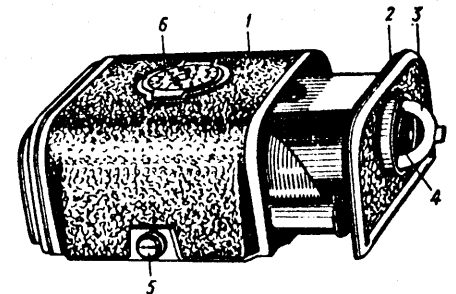

Fig. 27. Magazine:

1 - magazine housing 6.110.009; 2 - transport mechanism 6.006.000; 3 - lock 6.468.001; 4 - facing 8.645.026; 5 - button 8.337.507; 6 - scale 7.021.375

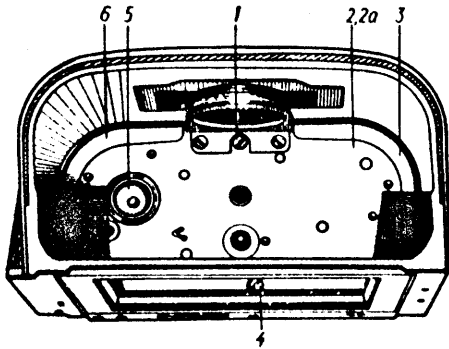

Fig. 28. Magazine mechanism housing:  
1 — screw 8.900.021; 2 — housing 6.110.009;  
2a — plate 8.610.008; 3 — angle 8.665.002; 4 —  
axle-screw 8.318.022; 5 — toothed wheel  
8.416.062; 6 — angle 8.665.001

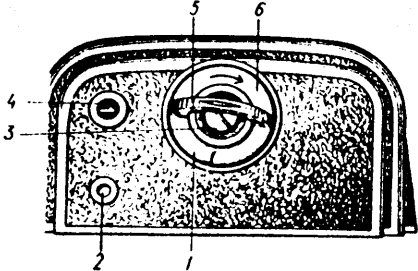

Fig. 30. Magazine as viewed from re-winding mechanism:

1 — washer 8.943.007; 2 — flag 7.027.000; 3 —  
screw 8.900.025; 4 — protective glass 6.436.002;  
5 — handle 8.337.000; 6 — handle 6.354.019

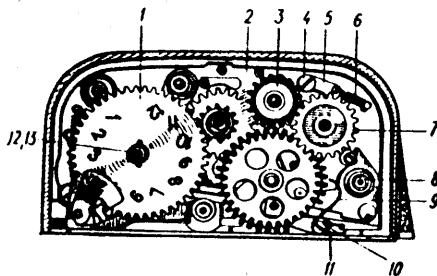

Fig. 32. Magazine mechanism without upper plate:

1 — scale 7.021.005; 2 — casing 6.110.009; 3 —  
gear 6.370.011; 4 — axle-screw 8.318.018; 5 —  
pawl 8.364.403; 6 — spring 8.380.009; 7 —  
winding wheel 6.370.118; 8 — axle 8.310.019;  
9 — spring 8.387.023; 10 — axle-screw 8.318.081;  
11 — retaining lever 6.354.055; 12 — washer  
8.942.078; 13 — washer 8.942.100

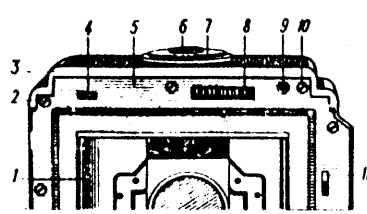

Fig. 29. Magazine housing as viewed from frame:

1 — roller 8.393.000; 2 — screw 8.903.012; 3 —  
cover 6.170.001; 4 — lever 8.332.029; 5 — frame  
6.122.750; 6 — facing 8.645.029; 7 — handle  
6.354.055; 8 — gear of drive 6.370.009; 9 —  
retaining lever 6.354.005; 10 — screw 8.903.013;  
11 — latch 6.272.005

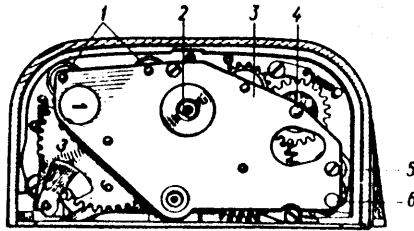

Fig. 31. Magazine mechanism without cover:

1 — axle 8.310.029; 2 — axle 8.310.022; 3 —  
upper plate 6.120.419; 4 — axle 8.310.027; 5 —  
screw 8.903.036; 6 — axle 8.310.028

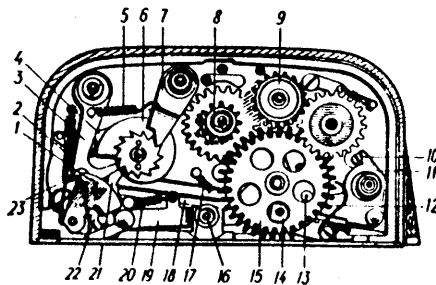

Fig. 33. Magazine mechanism without scale:

1 — flag-indicator 7.027.000; 2 — spring  
8.380.008; 3 — lever 6.351.015; 4 — locking lever  
8.332.024; 5 — spring 8.380.007; 6 — ratchet  
wheel with cam 6.275.001; 7 — lever  
6.354.017; 8 — gear 6.370.012; 9 — gear  
6.370.011; 10 — eccentric 8.360.006; 11 — lever  
6.354.014; 12 — gear of drive 6.370.009; 13 —  
rest 8.366.204; 14 — catch 8.262.008; 15 —  
gear 8.416.006; 16 — axle-screw 8.318.022;  
17 — spring 8.380.010; 18 — leverage 6.354.016;  
19 — lever 6.354.056; 20 — spring 8.380.006;  
21 — pawl 8.364.402; 22 — lever 8.332.029; 23 —  
axle 8.310.026

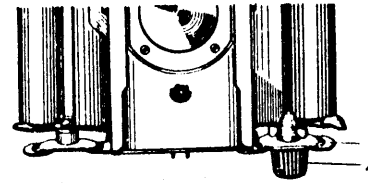

Fig. 34. Hinged cramps of transport mechanism:

1 — right-hand hinged cramp 6.463.001; 2 —  
handle 8.337.001

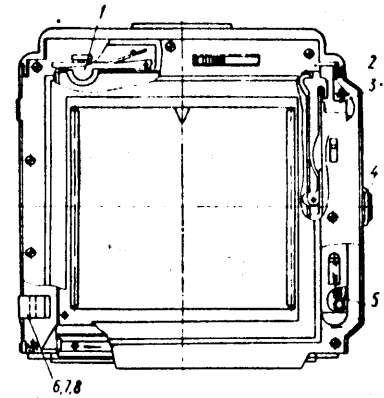

Fig. 35. Magazine interlocking devices:

1 — lever 8.332.032; 2 — lever 8.332.033; 3 —  
plate 8.610.005; 4 — button 8.337.507; 5 —  
spring 8.380.012; 6 — plate 8.610.007; 7 — plate  
8.610.009; 8 — plate 8.610.010

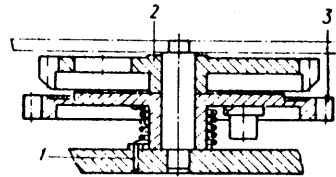

Fig. 36. Gear of magazine drive:

1 — return spring 8.385.020; 2 — gear  
8.416.006; 3 — rewinding mechanism 6.066.002

Fig. 37. Shutter in casing:

1 — plate 6.120.118; 2 — screw 8.903.040; 3 —  
angle 8.110.309; 4 — gear 8.410.040; 5 — cam  
6.365.027; 6 — screw 8.900.003; 7 — lower  
half-coupling 8.430.002; 8 — lever 8.332.251;  
9 — rest 8.366.529; 10 — axle with toothed  
wheel 6.304.055; 11 — casing 6.110.012; 12 —  
casing with mechanisms 5.822.010

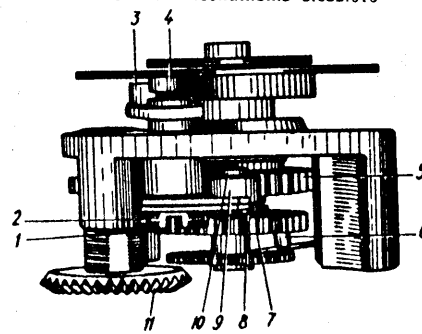
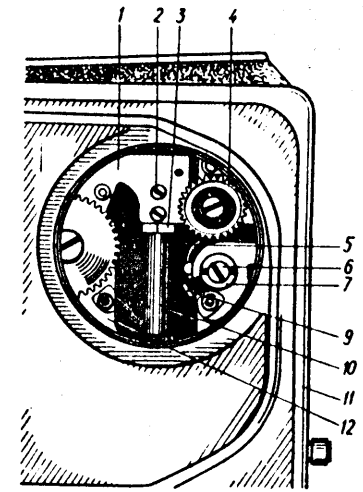

Fig. 38. Cocking knob (third view):

1 — spur gear 6.370.116; 2 — upper half-coupling  
8.340.046; 3 — rest 8.366.031; 4 — rest  
8.366.030; 5 — spur gear 6.370.117; 6 — hold-  
down 6.462.003; 7 — pawl 8.364.424; 8 — lever  
8.332.409; 9 — eccentric 8.360.603; 10 — screw  
8.900.961; 11 — coupled toothed wheel  
8.464.010

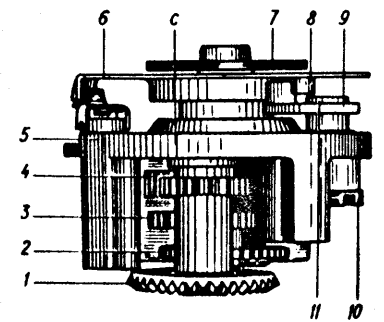

Fig. 39. Cocking knob (fourth view):

1 — coupled toothed wheel 8.464.010; 2 — gear  
8.410.029; 3 — spur gear 6.370.116; 4 — spur  
gear 6.370.117; 5 — base 6.120.116; 6 — cam  
6.365.002; 7 — axle 8.314.366; 8 — rest  
8.366.030; 9 — dog 6.360.001; 10 — upper half-  
coupling 8.340.025; 11 — screw 8.900.030; c —  
mark

Fig. 44. Prismatic viewfinder TTL (second view):  
1 - plug 8.656.625; 2 - facing 8.645.823; 3 - plate (contact) 7.725.322; 4 - switch 6.618.490

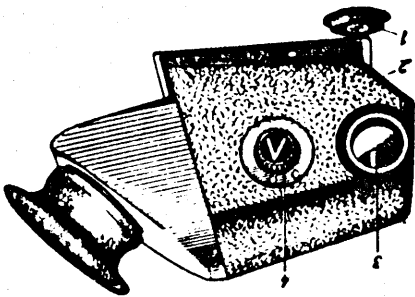

Fig. 42. Hood (second view):  
1 - button 8.337.511; 2 - cover 6.177.001; 3 - shield 8.632.004; 4 - wall with braces 6.424.003; 5 - shield 8.632.003

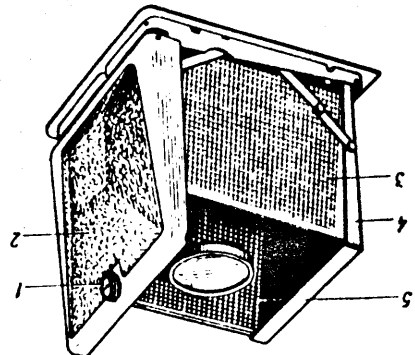

Fig. 40. Shutter curtain:  
1 - strip 8.610.017; 2 - roller 6.301.007

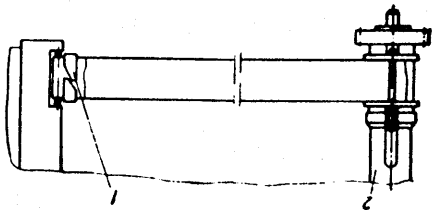

Fig. 45. Prismatic viewfinder TTL (third view):  
1 - screw 8.903.013; 2 - eyepiece 8.647.035; 3 - eyepiece 8.647.036

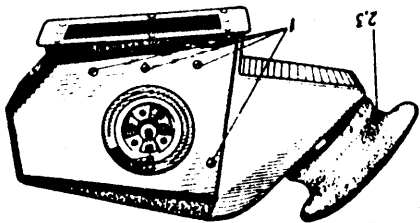

Fig. 43. Prismatic viewfinder TTL (first view):  
1 - screw 8.905.009; 2 - screw 8.903.017; 3 - screw 8.902.021; 4 - initial position of contact; 5 - washer 7.723.045; 6 - facing 8.645.824; 7 - frame 9.317.186

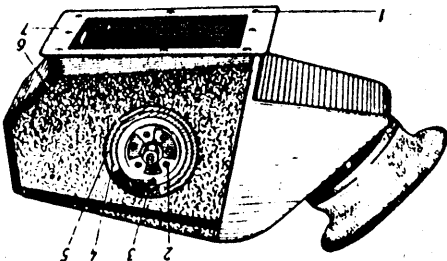

Fig. 41. Hood (first view):  
1 - spring 8.389.005; 2 - lever (lock) 8.332.011; 3 - base 6.120.004

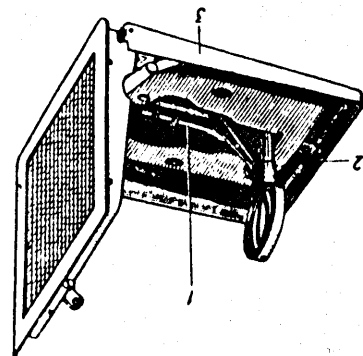

Fig. 46. Prismatic viewfinder TTL (fourth view):  
1 - screw 8.903.013; 1a - washer 8.912.957; 2 - casing 6.430.385; 3 - switch 6.618.490; 4 - screw 8.902.240; 5 - screw 8.903.013

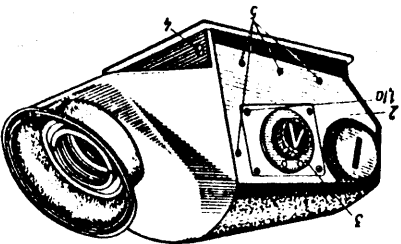

Fig. 47. Viewfinder exploded view 1:  
1, 2 - wire 7.760.130-02; 3, 4 - wire 7.760.130-01; 5 - photoresistor  $\Phi 11\Phi-7A$ ; 6 - housing 6.430.385

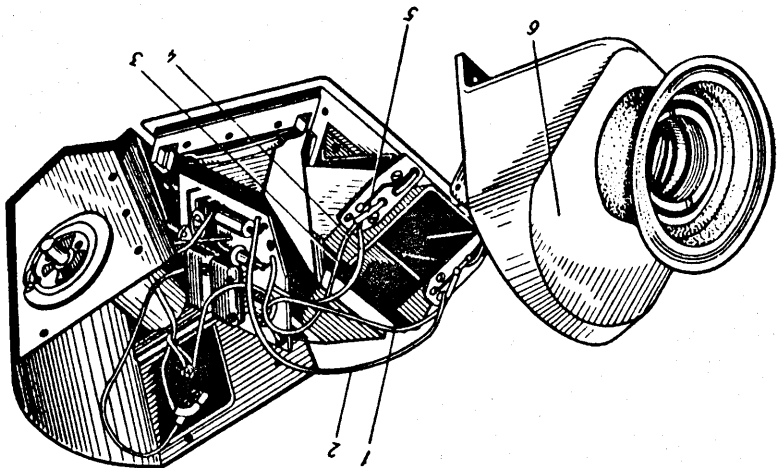
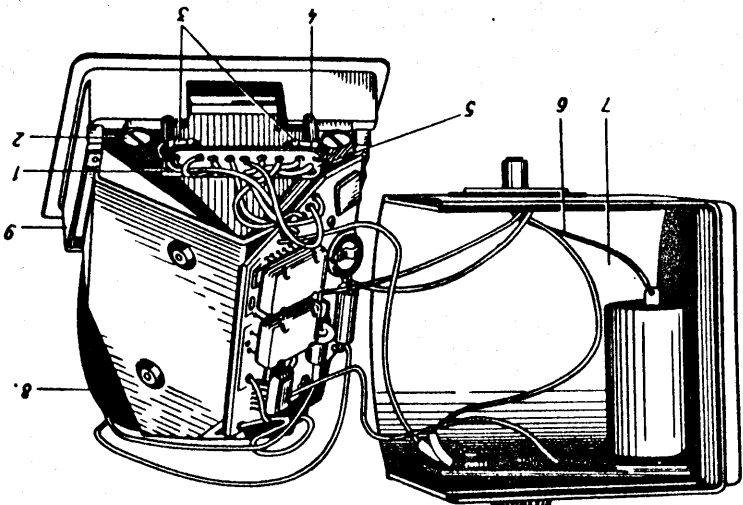

Fig. 48. Viewfinder exploded view 2:

1 - screw 8.909.422; 2 - screw 8.900.634; 3 - resistor OMJT-0.125-5.1 k $\Omega$ ; 4 - light-emitting diode unit 5.185.070; 5 - plate 7.103.196; 6 - wire 7.760.130-02; 7 - casing 6.430.385; 8 - exposure meter 5.185.081; 9 - base 8.060.599



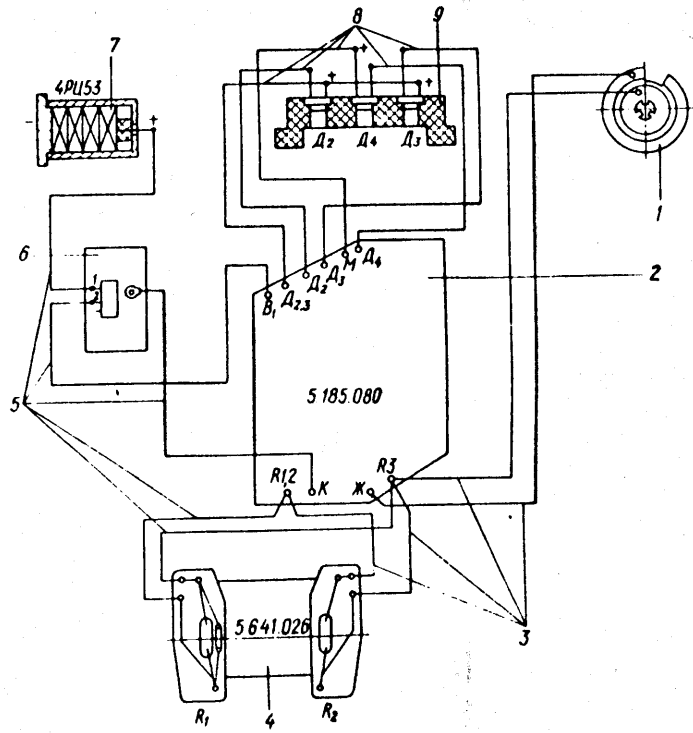

Fig. 49. Wiring diagram:

1 — resistor 7.723.015; 2 — illuminometer unit 5.185.080; 3 — wire 7.760.130-01; 4 — photoresistor unit 5.641.026; 5 — wire 7.760.130-02; 6 — switch 6.618.490; 7 — cell 4PI-53; 8 — wire 7.760.130; 9 — light-emitting diode unit 5.185.070

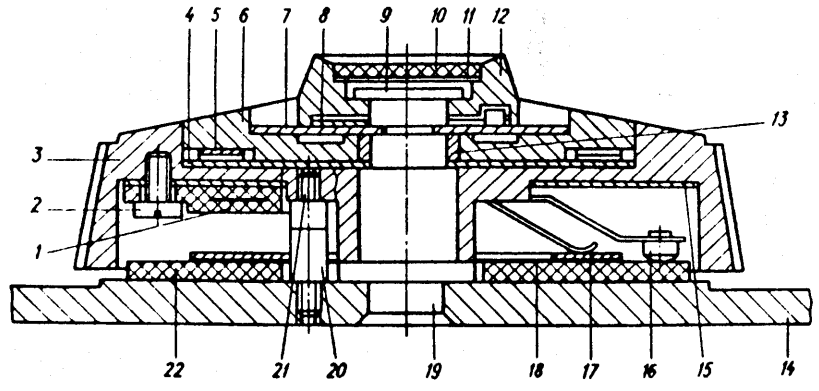

Fig. 50. Viewfinder calculator:

1 — plate (contact) 6.614.079; 2 — screw 8.902.000; 3 — scale 7.021.160; 4 — gasket 8.681.827; 5 — washer 8.943.011; 6 — scale 6.050.637; 7 — scale 6.050.638; 8 — washer 8.943.114; 9 — axle-screw 8.318.526; 10 — facing 8.645.656; 11 — gasket 8.681.097; 12 — hand wheel 8.330.379; 13 — ring 9.137.624; 14 — casing 6.430.385; 15 — gasket 7.841.170; 16 — contact 7.732.491; 17 — disk 7.723.035; 18 — gasket 7.814.296; 19 — axle 3.314.880; 20 — screw 8.909.431; 21 — screw 8.909.589; 22 — washer 7.723.015

Внешторгиздат. Изд. № 2744У/83.  
 Фотоаппараты «Киев 88», «Киев 88 TTL».  
 Руководство по ремонту на англ. яз.  
 К-фр. Зак. 3-1192.